

ČTVERCOVÁ VODROVNŇNÁ OSMA

5.17

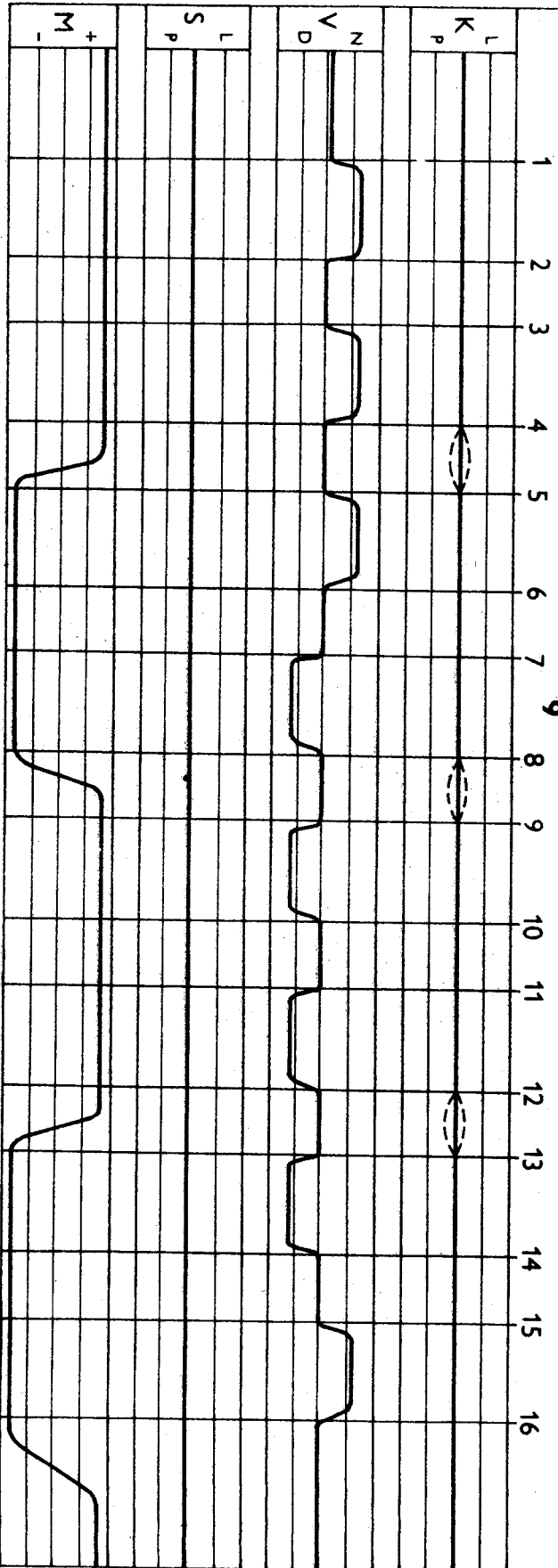

TŘI VÝKRUTY

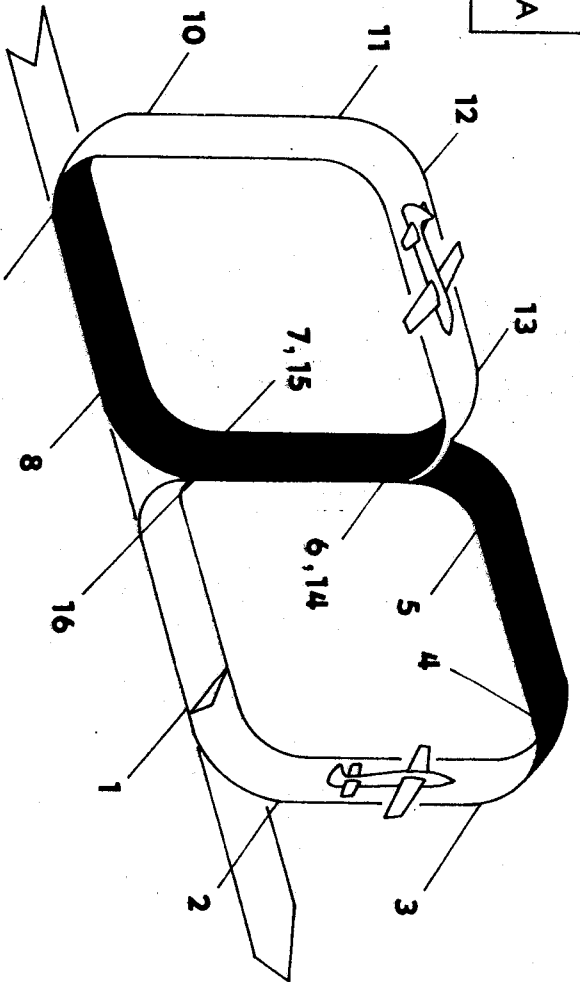
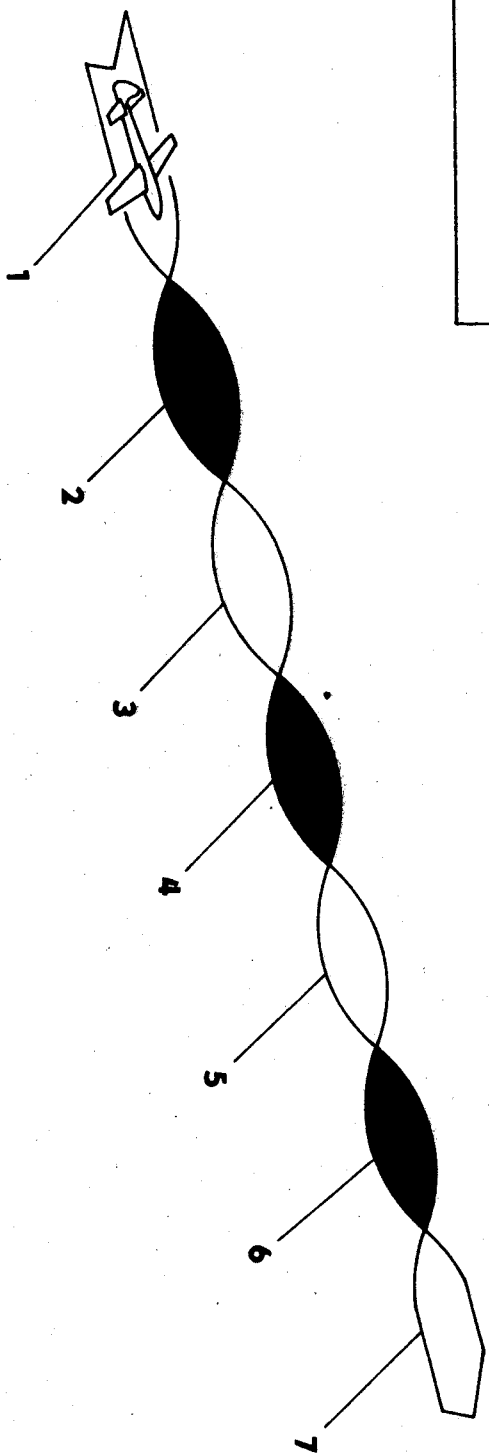

5.18

	1	2	3	4	5	6	7
L K P							
N D							
L S P							
+ M							

POMALÝ VÝKRUT

5.19

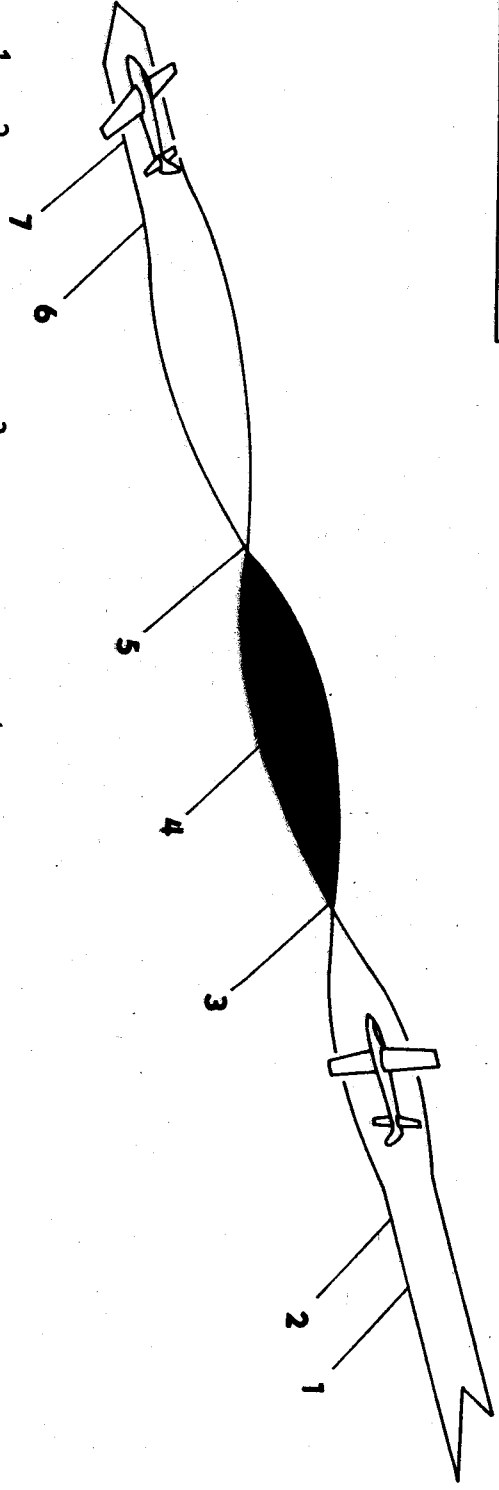

	1	2	3	4	5	6	7
K _p							
L _p							
V _D							
Z							
S _p							
L _p							
M ₊							
M ₋							

STOUPAVÝ VÝKRUT

5.20

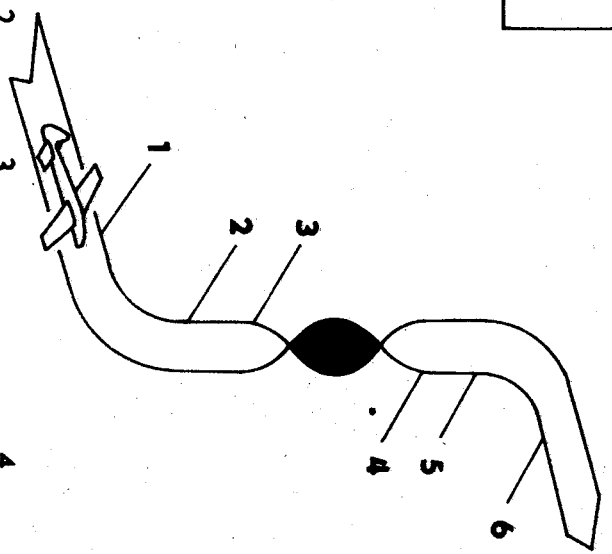

	1	2	3	4	5	6
L _p						
K _p						
Z						
D _D						
L _p						
S _p						
+						
M _i						

KLESAVÝ VÝKRUT

5.21

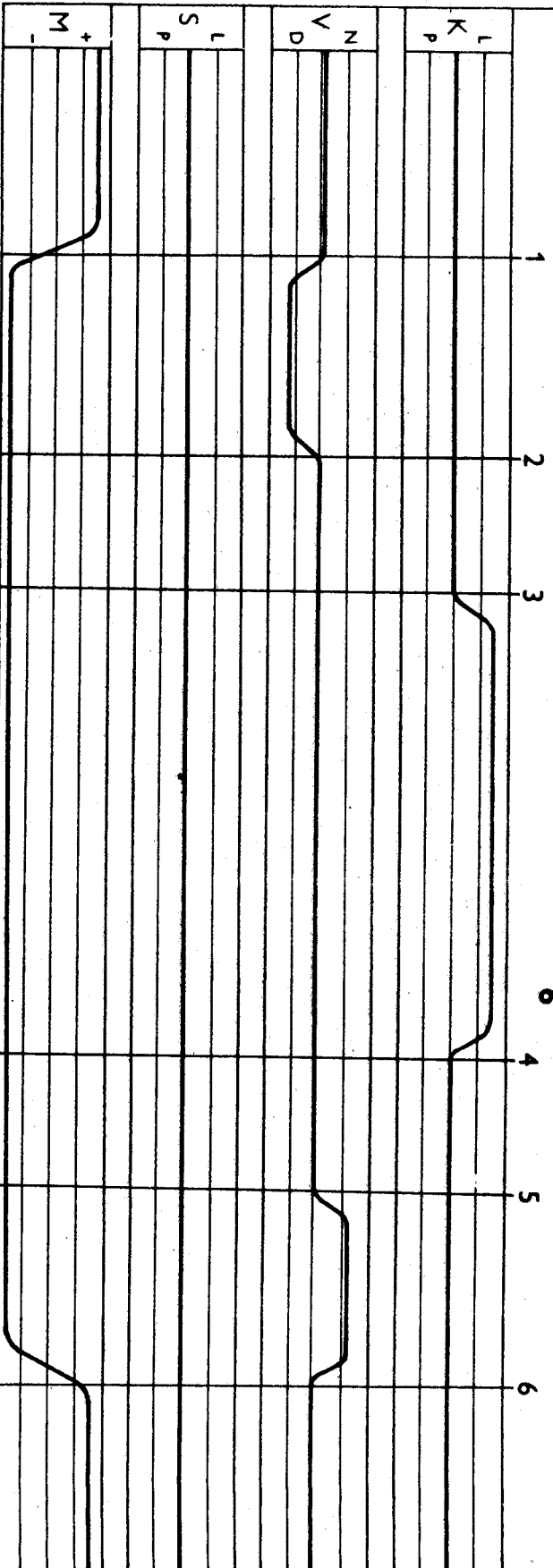
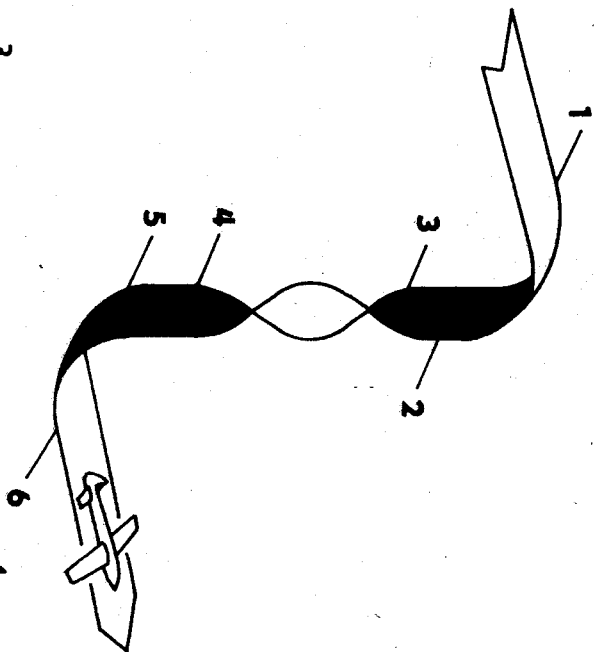

STRÍDAVÉ VÝKRUITY

5.22

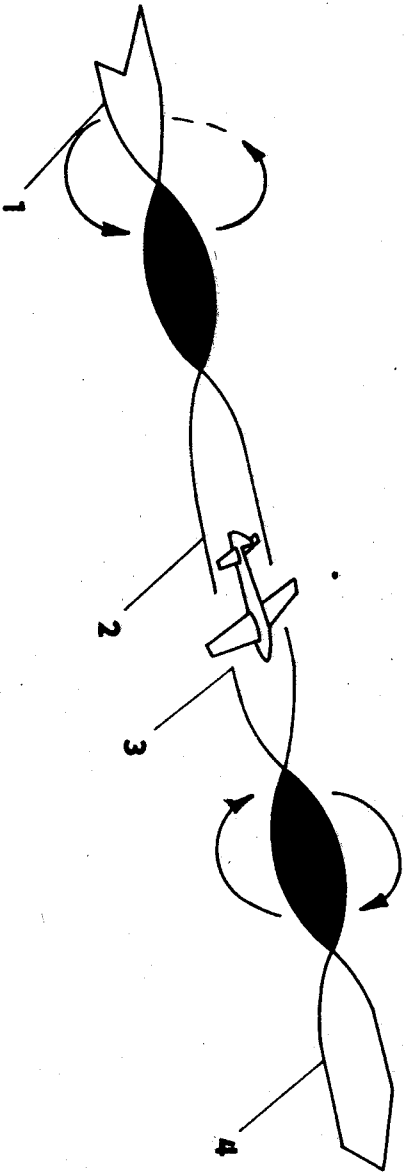

K _p	1	2	3	4
U				
V				
Z				
D				
L				
S _p				
M ₊				
M ₋				

ČTYŘBODOVÝ VÝKRUT

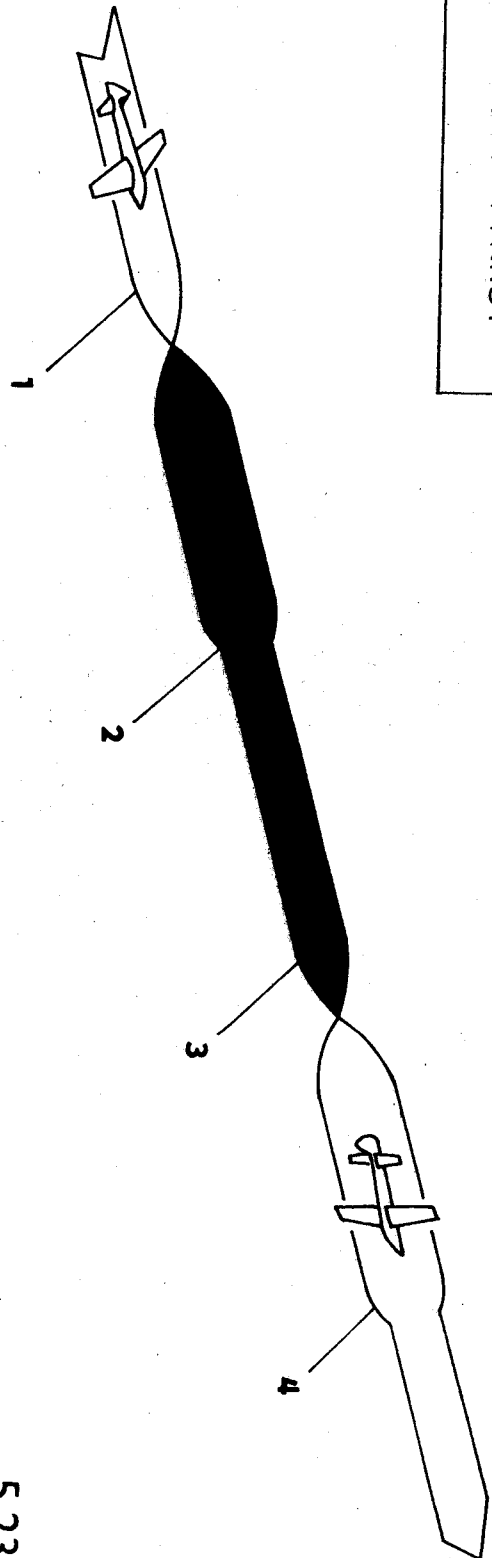

L K P	1	2	3	4
L N D				
L S P				
L +				
L M				

5.23

OSMIBODOVÝ VÝKRUT

5.25

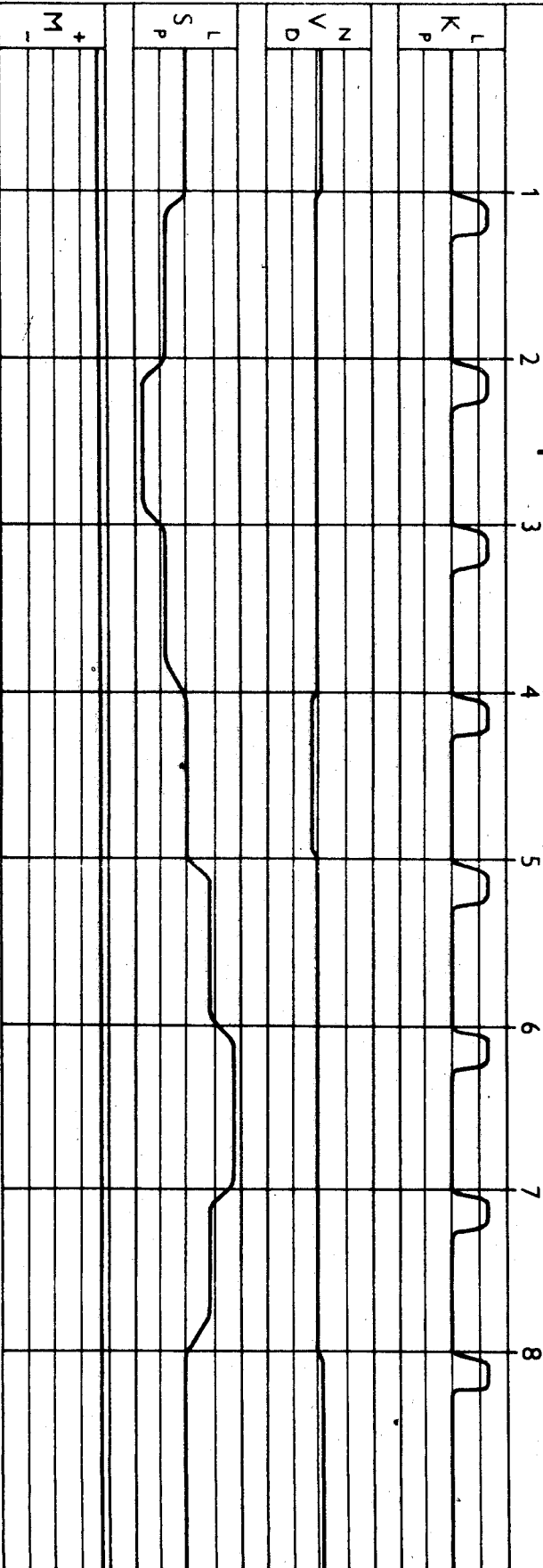
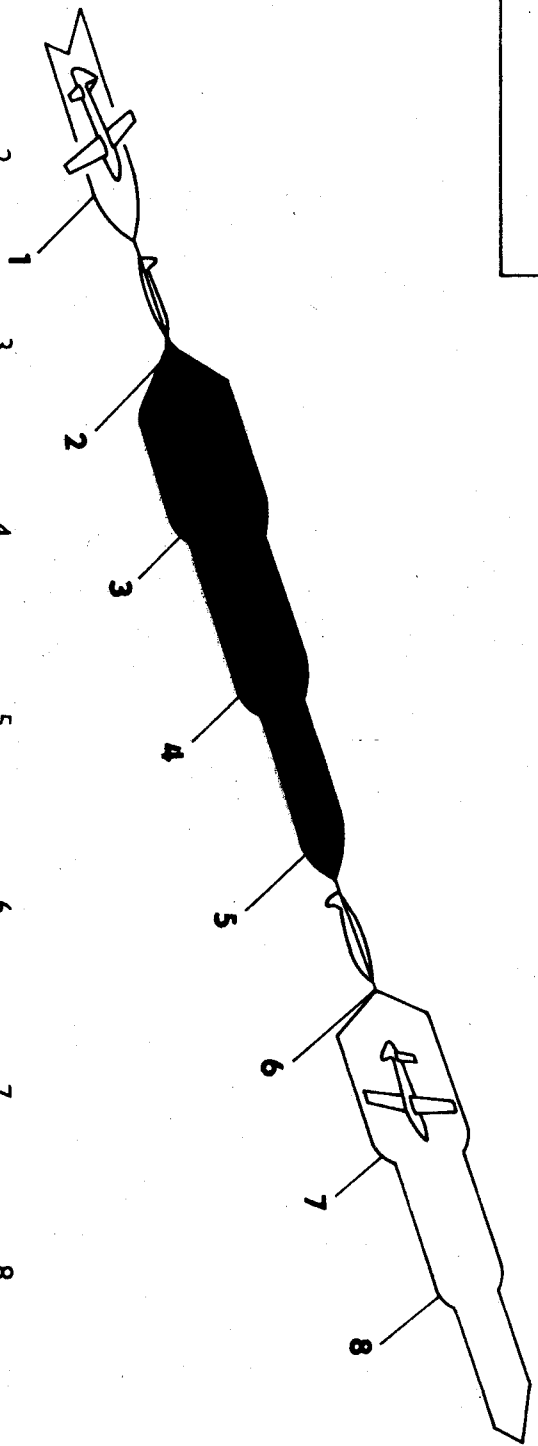

STRÍDAVÝ „KOPANÝ“ VÝKRUH

5.26

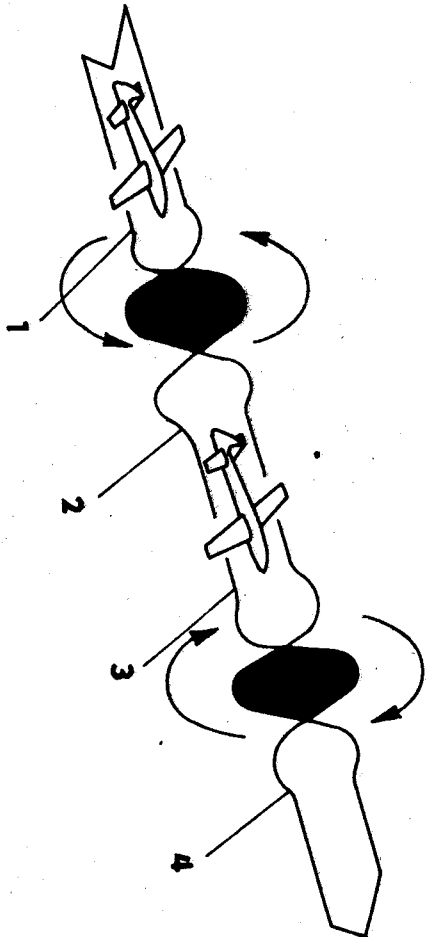

K _p	1	2	3	4
V _D				
S _p				
M ₊				

STRÍDAVÝ NOŽOVÝ LET

5.27

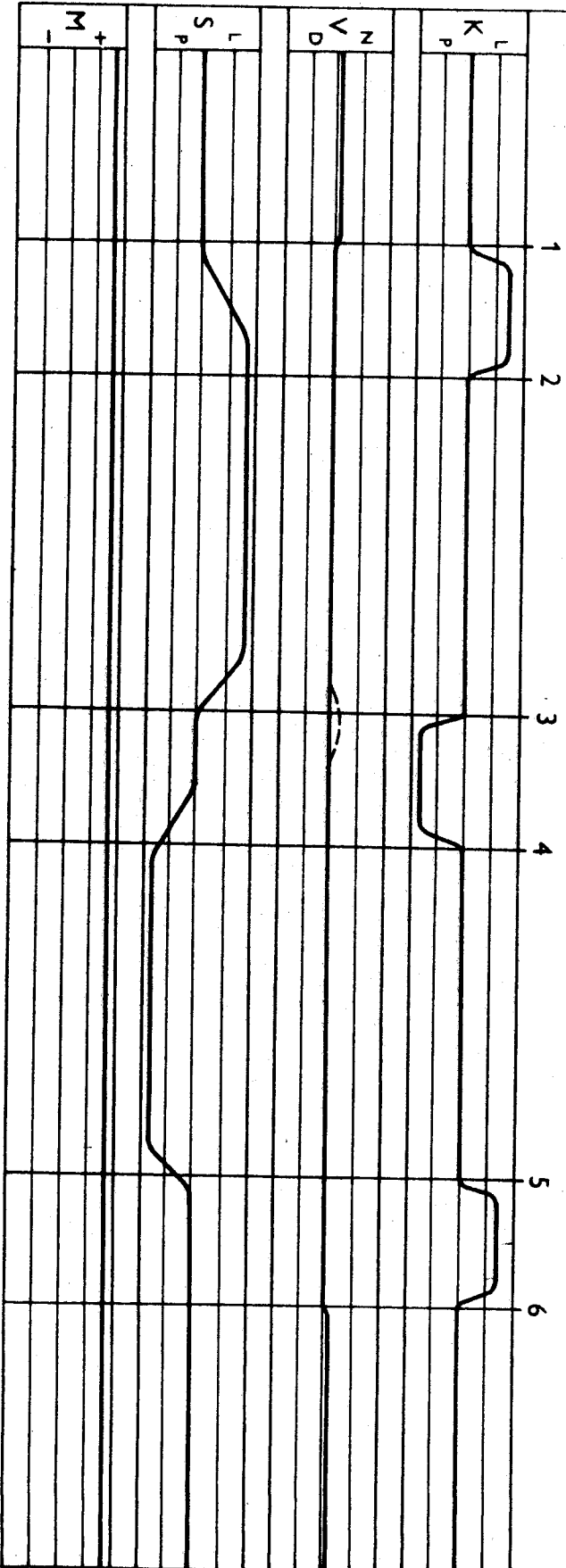
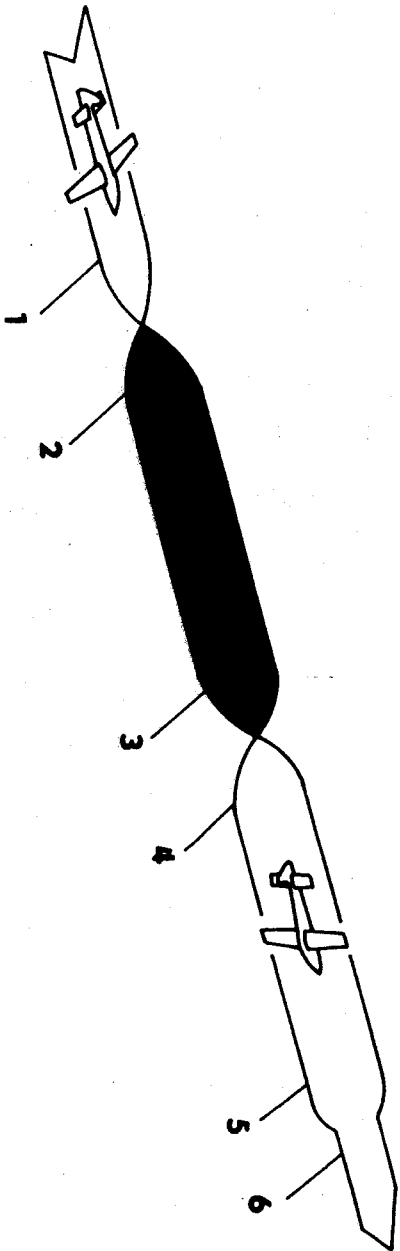

CYLINDER

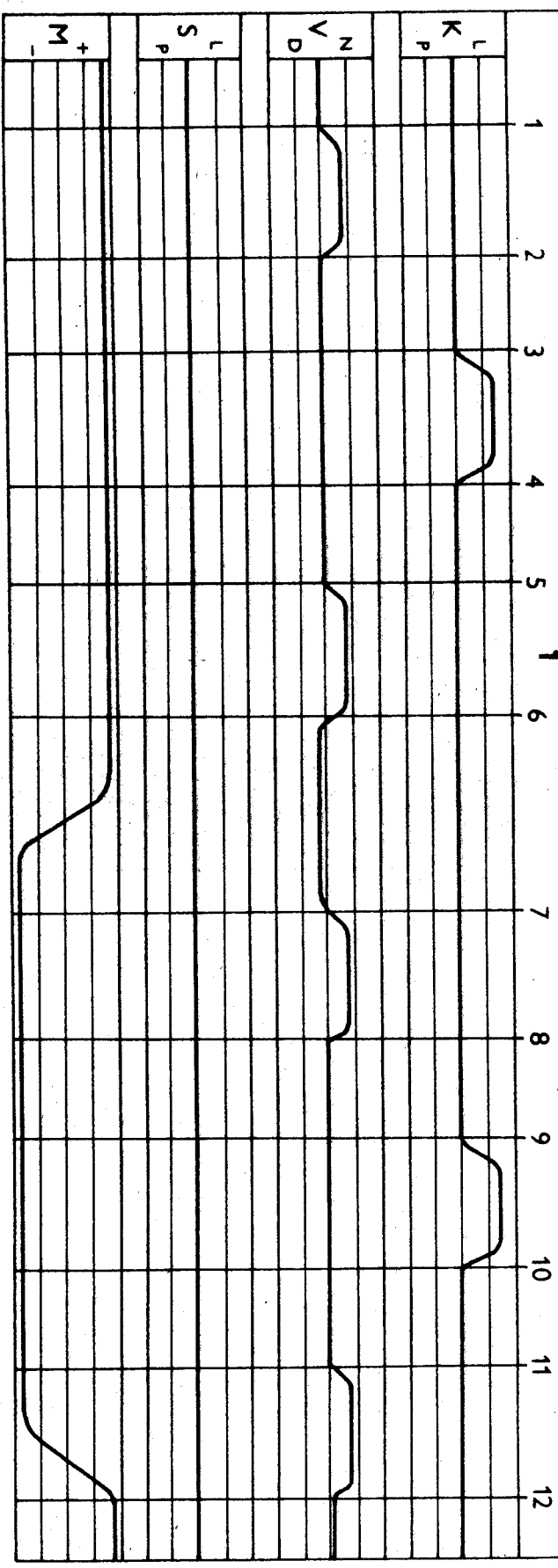
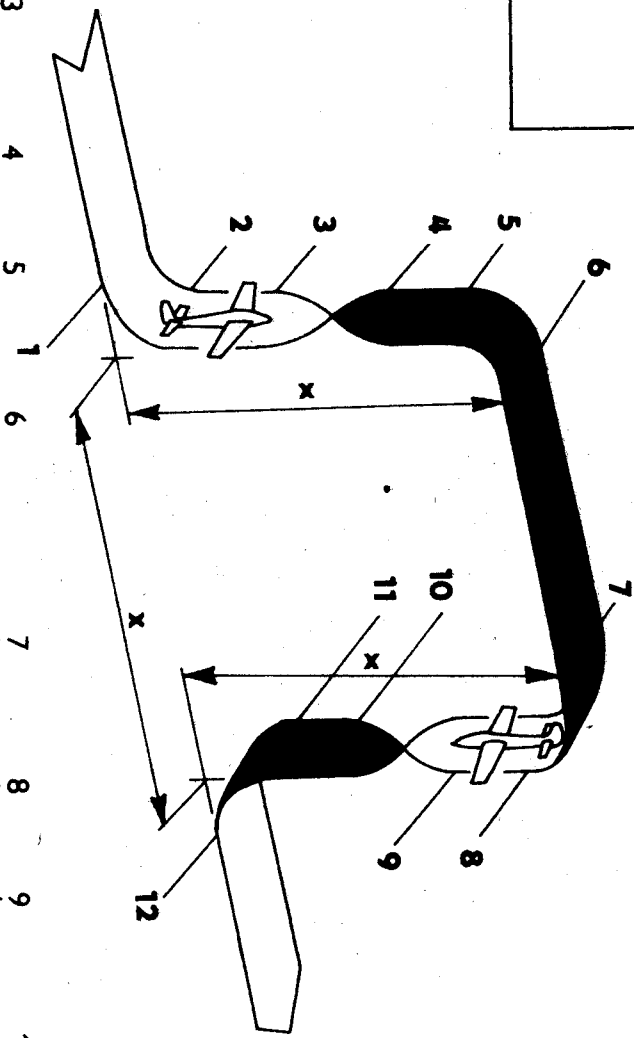

5.28

CYLINDR OBRÁCENĚ

1 2 3 4 5 6 7 8 9 10 11 12

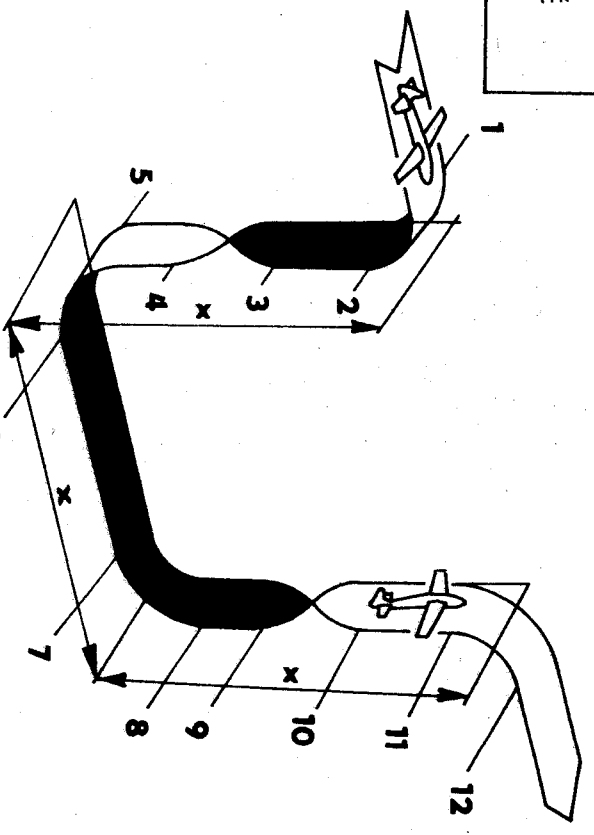
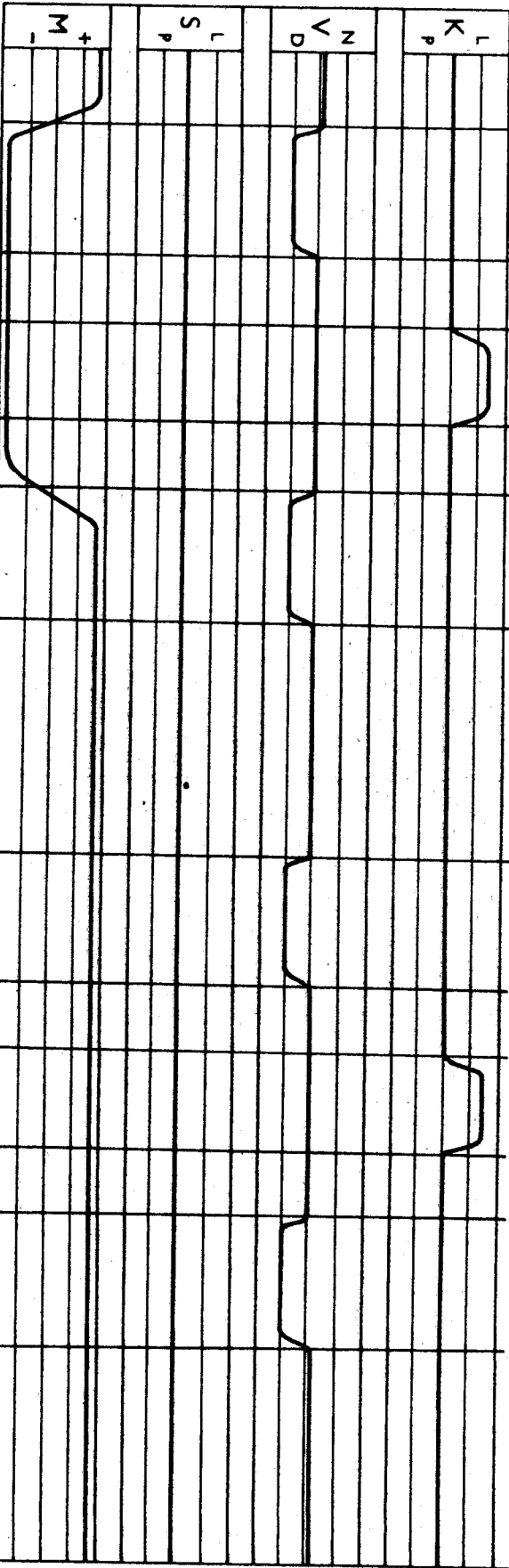

5.29

TROJÚHELNÍKOVÝ PŘEMET
S VÝKRUTEM

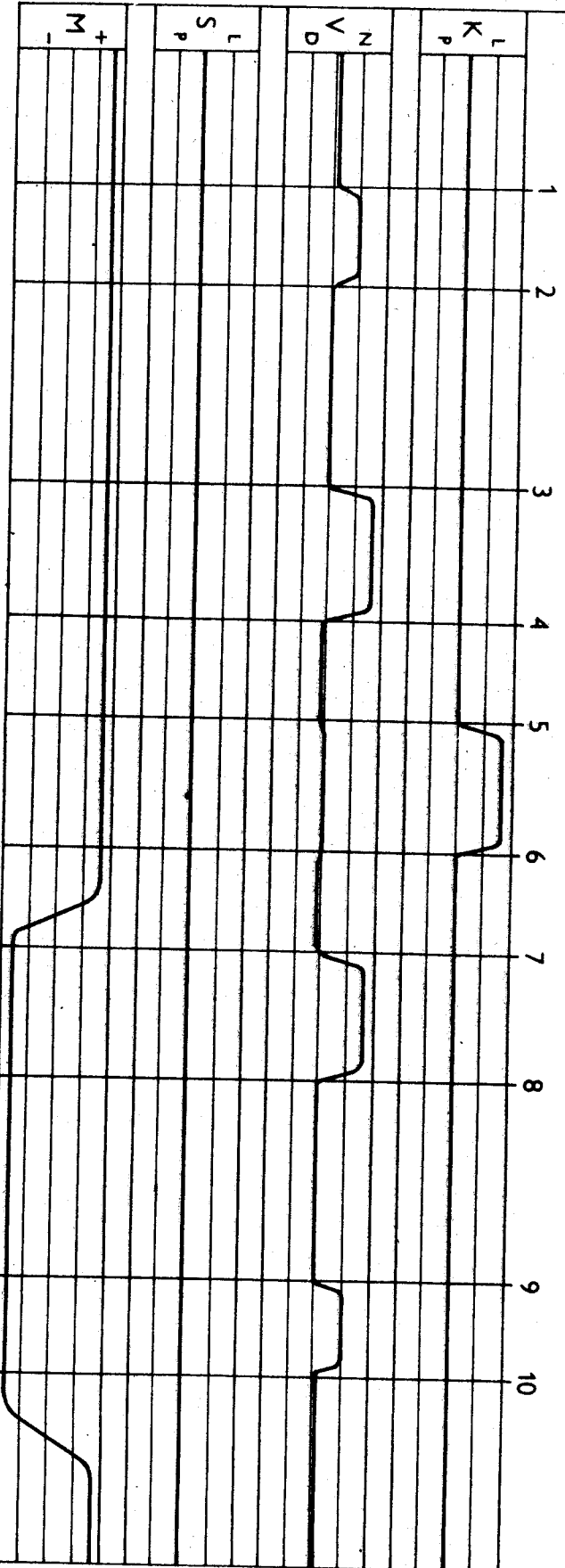
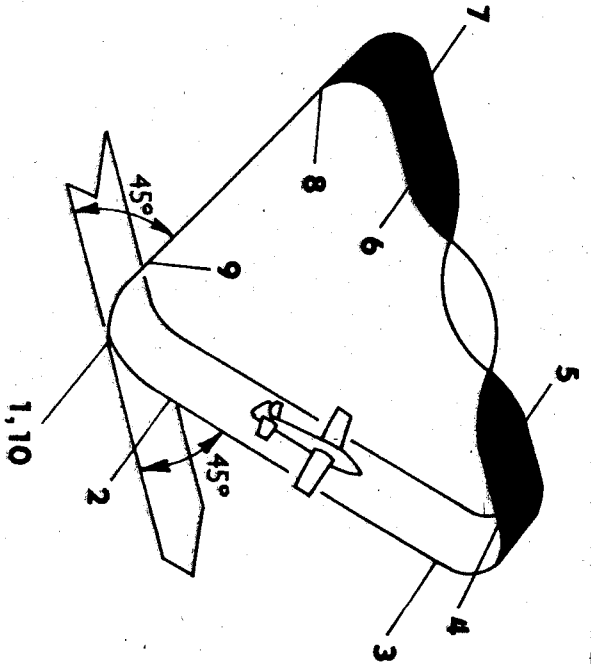

5.31

PISMENO „M“

5.32

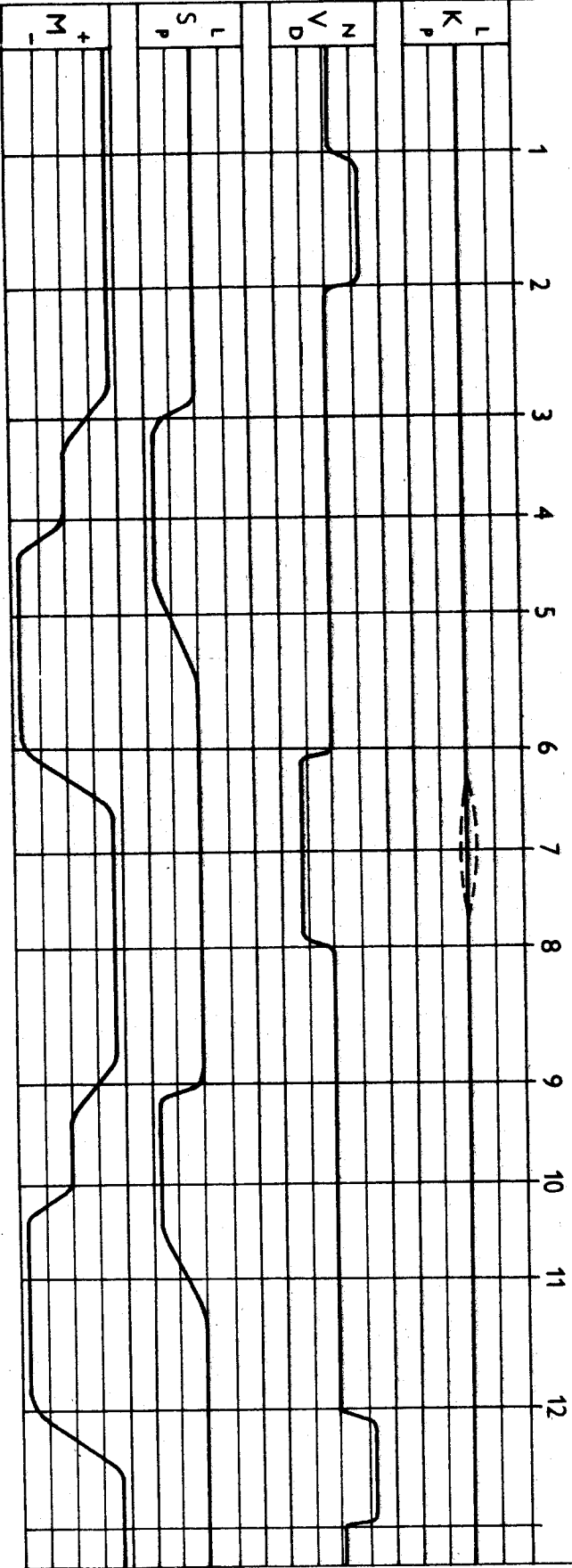
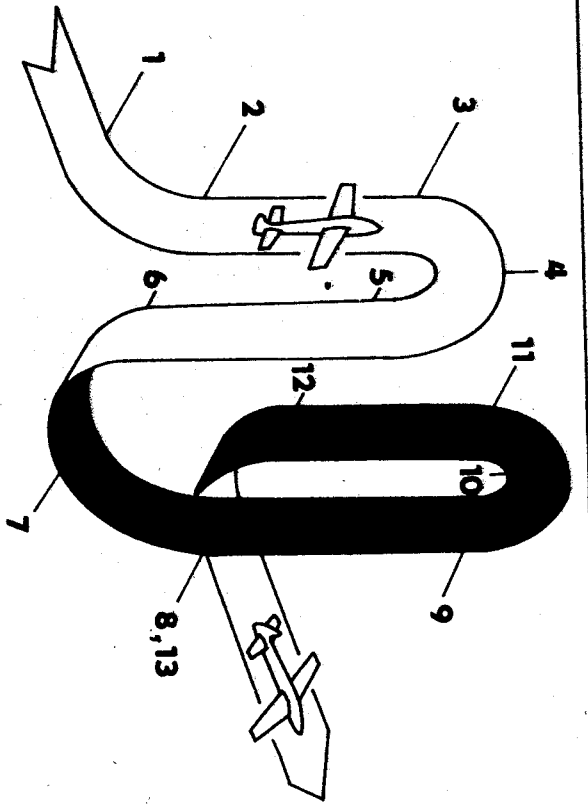

PÍSMENO „M“
S PŮLVÝKRUHY

5.33

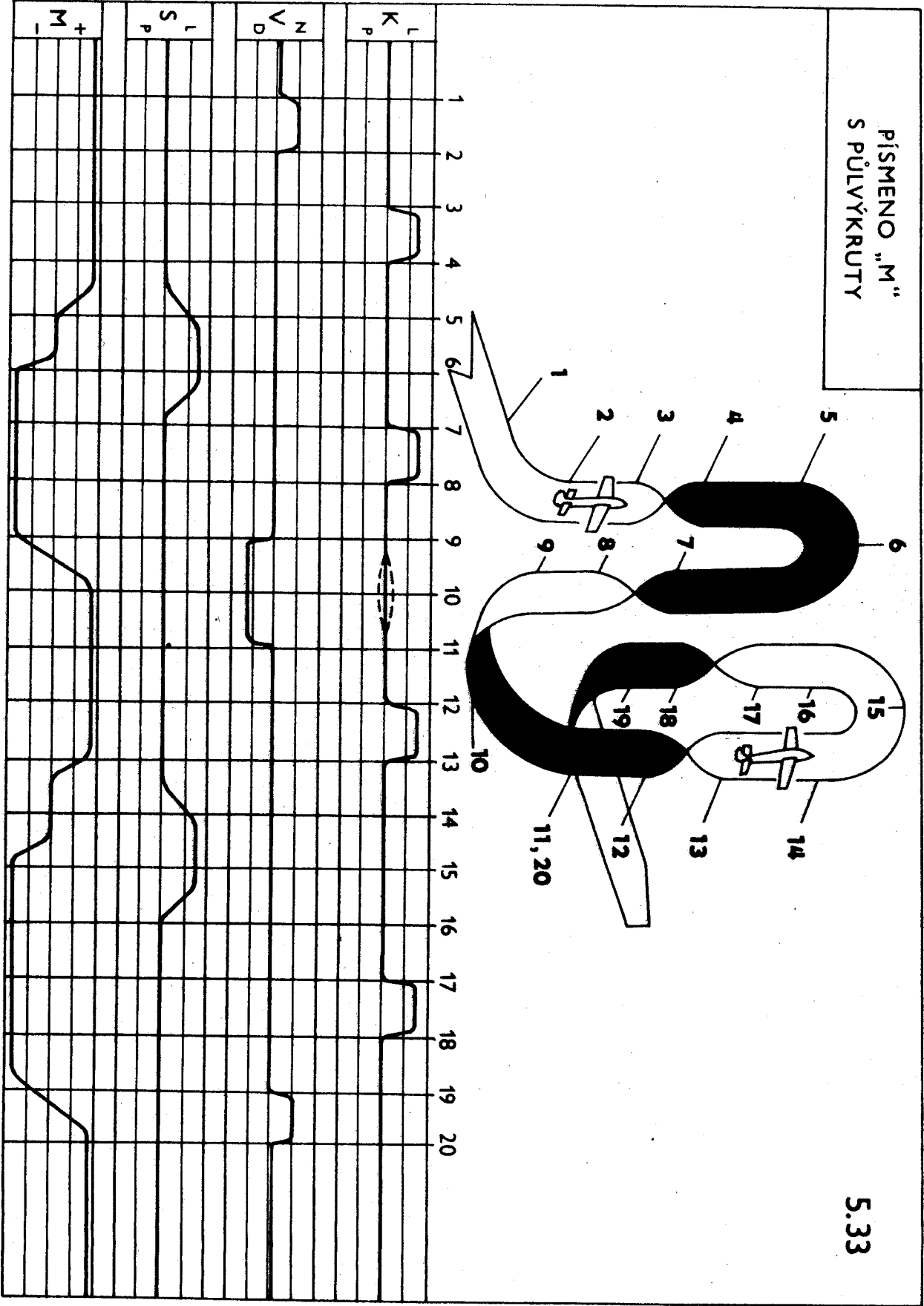

PÍSMENO „M“
SE ČTVRTVÝKRUTY

